

Instruction and operation manual

S 212

Dew point sensor



Dear Customer,
thank you for choosing our product.

The operating instructions must be read in full and carefully observed before starting up the device. The manufacturer cannot be held liable for any damage which occurs as a result of non-observance or non-compliance with this manual.

Should the device be tampered with in any manner other than a procedure which is described and specified in the manual, the warranty is cancelled and the manufacturer is exempt from liability.

The device is destined exclusively for the described application.

SUTO offers no guarantee for the suitability for any other purpose. SUTO is also not liable for consequential damage resulting from the delivery, capability or use of this device.

Table of contents

1. Safety instructions.....	4
2. Application.....	7
3. Features.....	7
4. Technical Data.....	8
4.1 General.....	8
4.2 Electrical Data.....	8
4.3 Output-Signals.....	8
4.4 Accuracy	9
5. Dimensional drawing.....	10
6. Determination of the installation point.....	11
7. Installation	11
7.1 Installation Requirements.....	11
7.2 Installation Procedure	12
7.3 Electrical connection	13
8. Signal outputs.....	14
8.1 Analog output	14
9. Optional extra accessories.....	14
9.1 Measuring chambers	14
9.2 Service kit.....	14
10. Calibration.....	15
11. Maintenance.....	15
12. Disposal or waste.....	15
13. Warranty.....	16

1. Safety instructions

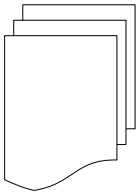

Please check if this instruction manual accords to the product type.

Please observe all notes and instructions indicated in this manual. It contains essential information which have to be observed before and during installation, operation and maintenance. Therefore this instruction manual has to be read carefully by the technician as well as by the responsible user / qualified personnel.

This instruction manual has to be available at the operation site of the dew point sensor at any time. In case of any obscurities or questions, regarding this manual or the product, please contact the manufacturer.



WARNING!

Compressed air!

Any contact with quickly escaping air or bursting parts of the compressed air system can lead to serious injuries or even death!

- Do not exceed the maximum permitted pressure range (see sensors label).
- Only use pressure tight installation material.
- Avoid that persons get hit escaping air or bursting parts of the instrument.
- The system must be pressureless during maintenance work.

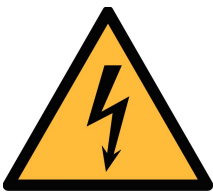

WARNING!

Voltage used for supply!

Any contact with energized parts of the product, may lead to a electrical shock which can lead to serious injuries or even death!

- Consider all regulations for electrical installations.
- The system must be disconnected from any power supply during maintenance work.
- Any electrical work on the system is only allowed by authorized qualified personal.



WARNING!

Permitted operating parameters!

Observe the permitted operating parameters, any operation exceeding this parameters can lead to malfunctions and may lead to damage on the instrument or the system.

- Do not exceed the permitted operating parameters.
- Make sure the product is operated in its permitted limitations.
- Do not exceed or undercut the permitted storage and operation temperature and pressure.
- The product should be maintained and calibrated frequently, at least annually.

General safety instructions

- It is not allowed to use the product in explosive areas.
- Please observe the national regulations before/during installation and operation.

Remarks

- It is not allowed to disassemble the product.
- Always use spanner to mount the product properly.



ATTENTION!

Measurement values can be affected by malfunction!

The product must be installed properly and frequently maintained, otherwise it may lead to wrong measurement values, which can lead to wrong results.

Storage and transportation

- Make sure that the transportation temperature of the sensor is between -30°C ... 70°C .
- For transportation it is recommended to use the packaging which comes with the sensor.
- Please make sure that the storage temperature of the sensor is between -10°C ... 50°C .
- Avoid direct UV and solar radiation during storage.
- For the storage the humidity has to be $<90\%$, no condensation.

2. Application

The S 212 is a dew point sensor which is designed to monitor the dew point in industrial application within the permissible operating parameters. These parameters can be found in the technical data section.

The S 212 can measure the following values:

- Temperature of the compressed air or gas.
- Humidity of the compressed air or gas.
- Dew point of the compressed air or gas.

The default factory settings are: temperature in °C, Humidity in % and dew point in °Ctd. Other units can be programmed by the optional display or the service kit.

The S 212 dew point sensor is not developed to be used in explosive areas. For the use in explosive areas please contact the manufacturer.

The S 212 dew point sensor is mainly used in compressed air systems in industrial environment.

3. Features

- Dew point sensor for low dew point applications down to -50 °Ctd.
- Long term stability.
- IP65 casing provides robust protection in rough industrial environment.
- Very fast response time ensures safe and reliable indication whenever dew points are out of valid ranges.
- Can be installed directly into dryer through G 1/2" thread.
- High accuracy of $\pm 2^{\circ}\text{Ctd}$ dew point.

4. Technical Data

4.1 General

CE	
Parameters	Standard unit dew point: °Ctd Standard unit temperature: °C other units: °F, K Standard unit humidity: %
Principle of measurement	Capacitive method
Measuring range	Dew point: -50°Ctd... 20°Ctd Relative humidity: 0... 99.9% Temperature: -30°C... 70°C
Sensor	polymer
Measuring medium	Non-corrosive gases
Ambient temperature	-20°C... 50°C
Operating pressure	-0.1... 5.0 MPa
Casing material	Zinc alloy
Protection class	IP65
Dimensions	See dimensional drawing on the next page
Screwing thread	G ½" thread (ISO 228/1); UNF 5/8" thread (on request)
Weight	0.2 kg

4.2 Electrical Data

Power supply	12... 30 VDC / 60 mA
--------------	----------------------

4.3 Output-Signals

Analog output	4... 20 mA, 3 wire
Analog output scaling	4 mA = -50°Ctd 20 mA = 20°Ctd

4.4 Accuracy

Accuracy	$\pm 2^{\circ}\text{Ctd}$ dew point (see picture below)
Repeatability	$\pm 0.5^{\circ}\text{C}$
Stated accuracy at	Ambient/process temperature $23^{\circ}\text{C} \pm 3^{\circ}\text{C}$ Process temperature $23^{\circ}\text{C} \pm 3^{\circ}\text{C}$ Ambient/process humidity $<90\%$, no condensation Airflow $> 1 \text{ l/min}$ at sensor tip

Accuracy:

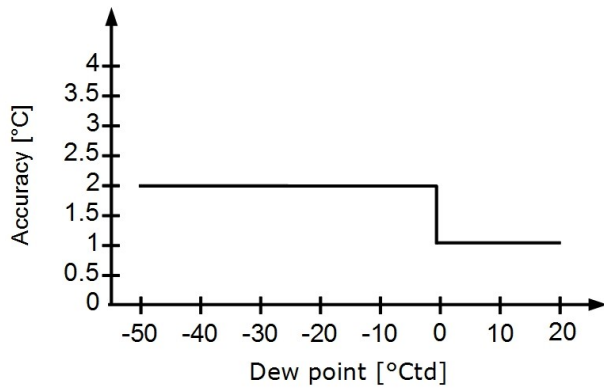

Valid working range:

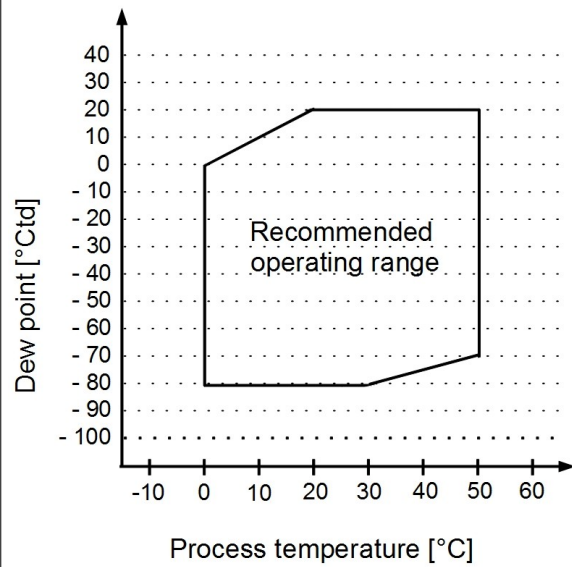

5. Dimensional drawing

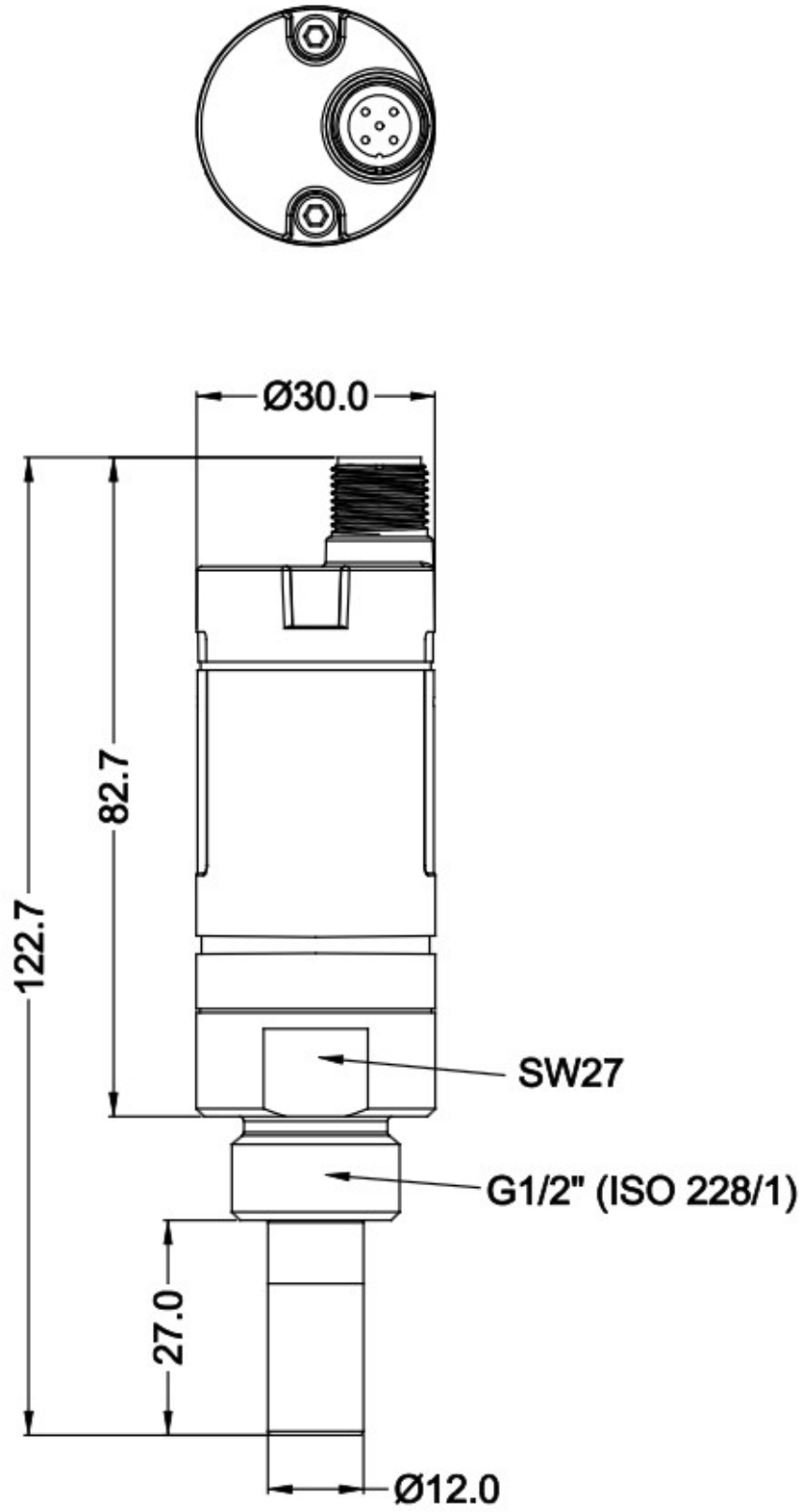

6. Determination of the installation point

In order to maintain the accuracy stated in the technical data, the sensor must be installed correctly. The air must flow on to the sensor tip, otherwise it will lead to wrong measurement values. For further instructions, please read the next chapter carefully.

Please consider that enough space exists at your site for a adequate installation as described in this manual.



ATTENTION!

Wrong measurement is possible, if the sensor is not installed correctly.

- The sensor is for indoor use only! At an outdoor installation, the sensor must be protected from solar radiation and rain.
- It is strongly recommend not to install S 212 permanently in wet environment as it exists usually right after a compressor outlet.

7. Installation

Before installing the sensor, please make sure that all components listed below are included in your package.

Qty	Description
1	Sensor
1	M12 plug
1	Instruction manual
1	Calibration certificate

7.1 Installation Requirements

The flowing air or gas has to pass the sensor tip for a proper measurement. This can be realized with a measurement chamber. For a installation without measuring chamber you need to concern the installation depth which is described in the next chapter.

7.2 Installation Procedure

The following steps explain the procedure of an appropriate installation.

Installation of the sensor with measurement chamber

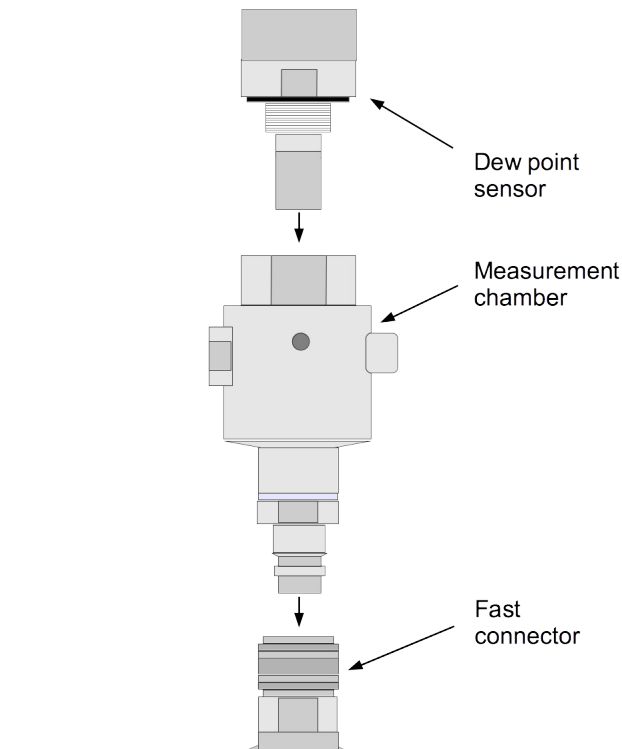

1. connect the sensor with the measurement chamber.
2. Connect the sensor and the measurement chamber with the fast connector.

Installation of the sensor without measurement chamber

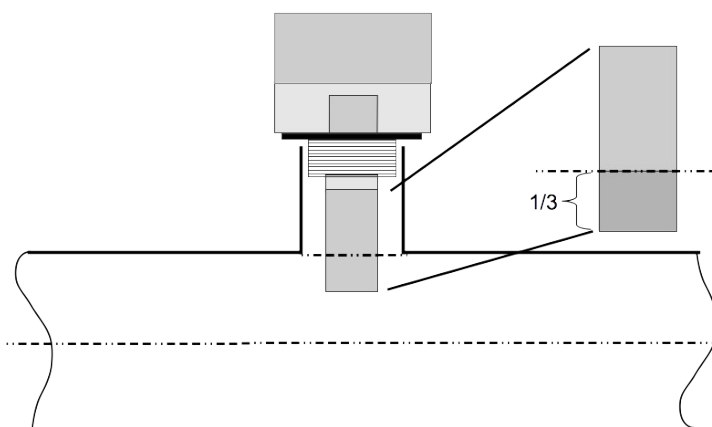

- Install the sensor only if the system is pressureless.
- Not less than 1/3 of the sensor tip should be inside of the pipe. For this please check the size of the nozzle.
- The inner thread has to be G 1/2".

Remarks

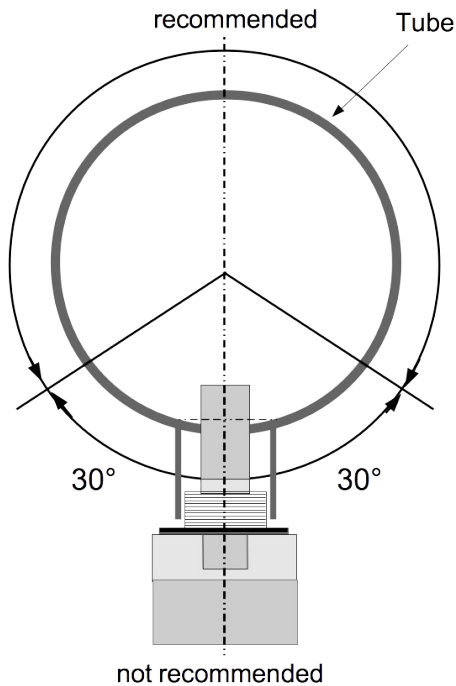

Please install the sensor only in the recommended area like you can see in the picture. A upside down installation is not permitted. Please consider that the distance to the vertical level must be $>30^\circ$.

Removal of the sensor

To remove the sensor unscrew the sensor from the measurement chamber or from the nozzle. Please observe that the system is pressureless when the sensor is removed.

7.3 Electrical connection

Connection pins connector plug M12

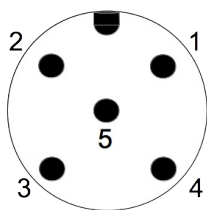

Connection pins (view from the clamping side)

Pin assignment connector plug M12

Pin 1	Pin 2	Pin 3	Pin 4	Pin 5
SDI	$-V_B$	$+V_B$	+I 4...20 mA	N/A
brown	white	blue	black	grey

Legend to pin assignment

SDI	Digital signal (internal use)
$-V_B$	Negative supply voltage
$+V_B$	Positive supply voltage
+I	Active 4...20 mA signal
N/A	Not available



ATTENTION!

Do not screw the M12 plug using force. Otherwise, it may damage the connecting pins.

8. Signal outputs

8.1 Analog output

The sensor has an analog output range of 4... 20 mA. It is a 3-wire active analog output. This output is scaled to:

- 4 mA = -50°Ctd
- 20 mA = 20°Ctd

For other ranges, please contact the manufacturer. The analog output can be allocated to the temperature, the dew point and the humidity.

9. Optional extra accessories

9.1 Measuring chambers

There are different types of measuring chambers for example Measuring chamber with fast connector, by-pass-by chamber with in and out connection, measuring chamber for dryer installation or high pressure chamber. For more information please contact your retailer or the manufacturer.

9.2 Service kit

The service kit is used to connect the sensor with the PC. Sensor parameters such as analog output scaling, alarm values, units etc. can be easily changed by using the service kit.

The diagram below shows the connection when using the optional service kit. Please ensure that also in this case the power supply of either S 212 or of the service kit is connected because the USB port is not supplying enough power.

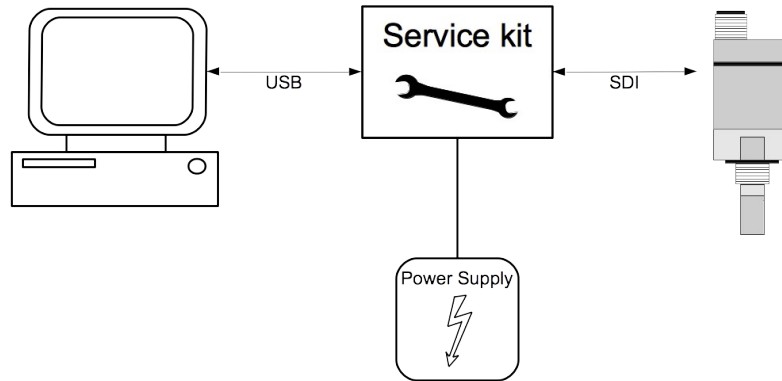

10. Calibration

The sensor is calibrated ex work. The exact calibration date is printed on the certificate which is supplied together with the sensor. The accuracy of the sensor is regulated by the on site conditions, parameters like oil, high humidity or other impurities can affect the calibration and furthermore the accuracy. However we recommend to calibrate the instrument at least once per year. The calibration is excluded from the instruments warranty. For this please contact the manufacturer.

11. Maintenance

Please observe from time to time the sinter cap. If it appears to be dirty, it is recommended to replace it for this please contact the manufacturer.



ATTENTION!

Contaminated filters can lead to longer response time and to wrong measurements.

12. Disposal or waste

Electronic devices are recyclable material and do not belong in the household waste.

The sensor, the accessories and its packings must be disposed according to your local statutory requirements. The dispose can also be carried by the manufacturer of the product, for this please contact the

manufacturer.

13. Warranty

SUTO provides a warranty for this product of 24 months covering the material and workmanship under the stated operating conditions from the date of delivery. Please report any findings immediately and within the warranty time. If faults occurring during the warranty time SUTO will repair or replace the defective unit, without charge for labour and material costs but there is a charge for other service such as transport and packing costs.

Excluded from this warranty is:

- Damage caused by:
 - Improper use and non-adherence to the instruction manual.
 - Use of unsuitable accessories.
 - External influences (e.g. damage caused by vibration, damage during transportation, excess heat or moisture).

The warranty is cancelled:

- If the user opens the measurement instrument without a direct request written in this instruction manual.
- If repairs or modifications are undertaken by third parties or unauthorised persons.
- If the serial number has been changed, damaged or removed.

Other claims, especially those for damage occurring outside the instrument are not included unless responsibility is legally binding.

Warranty repairs do not extend the period of warranty.



ATTENTION!

Batteries have a reduced warranty time of 12 month.

SUTO iTEC GmbH

Werkstr. 2
79426 Buggingen
Germany

Tel: +49 (0) 7631 936889-0
Fax: +49 (0) 7631 936889-19
Email: sales@suto-itec.com
Website: <http://www.suto-itec.com>

SUTO iTEC Co., Ltd.

Room 10, 6/F, Block B, Cambridge Plaza
188 San Wan Road, Sheung Shui, N.T.
Hong Kong

Tel: +852 2328 9782
Fax: +852 2671 3863
Email: sales@suto-itec.asia
Website: <http://www.suto-itec.com>